

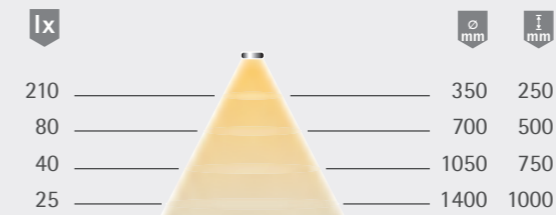

Light distribution diagram 70°

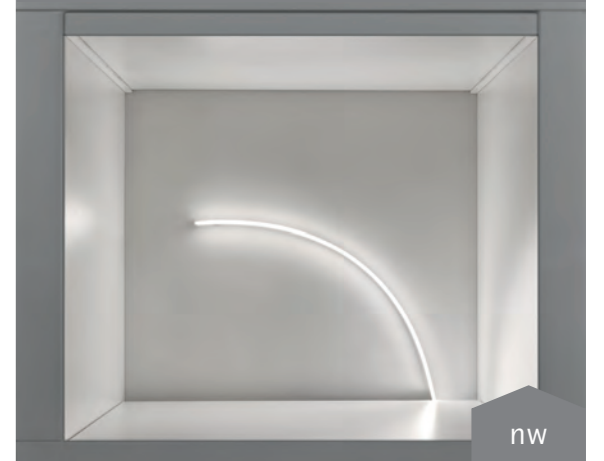

Light box



Versa SuperPlus Mini

Advantages

- ▶ Evenly illuminated area
- ▶ Lateral bending direction (see drawing)
- ▶ Flush mounting possible
- ▶ Can be individually cut to size

Features

- ▶ Protection against water jets from all directions
- ▶ Suitable for damp locations (IP 44)
- ▶ Supply lead on both sides (one cut, two lights), see drawing

Examples of use

- ▶ Round counters
- ▶ Decorative surfaces with visible curves
- ▶ Particularly narrow cabinet interior lighting

Versa Super Plus Mini

	WarmWhite	NeutralWhite
1200 mm (max. 7.2 W)	55 864 12	55 864 02
5000 mm (max. 30 W)	55 864 13	55 864 03

Accessories*

LED ballast with Euro flat plug (15 W)	30 996 17
LED ballast with Euro flat plug (30 W)	31 002 07
M1 extension lead 1800 mm	36 768 01
M1 3-way distributor 180 mm	36 852 01

Technical details



Luminaire type: LED surface-mounted/recessed light
Type of lighting: Accent lighting
Operating voltage: 12 V DC
Light colours: WarmWhite/NeutralWhite
Colour rendering: RA >80
Luminous flux: 150 lm/m
Luminaire efficiency: 25 lm/W
Light source efficiency: 115 lm/W
Life span: 40,000 h (L70)
Power consumption: 6 W/m
Max. length at a stretch: 5 m
Dimmable: Yes/PWM/Smart.home
Beam angle: 120°
Half value angle: 70°
Test mark and symbols: CE, RoHS, Energy Star, ENEC
Protection rating: IP 44 (Only in the gated area)
Supply lead: 2 x 1800 mm
Plug connector: LED mini, M1 plug connector
Connection to: LED ballast

Dimensional drawing / installation

Can be individually cut to size

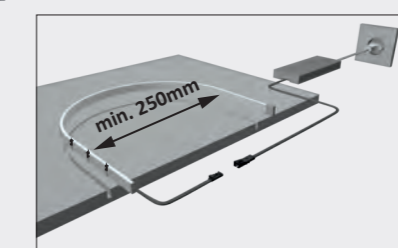
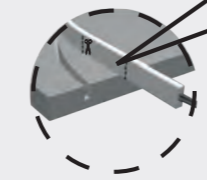
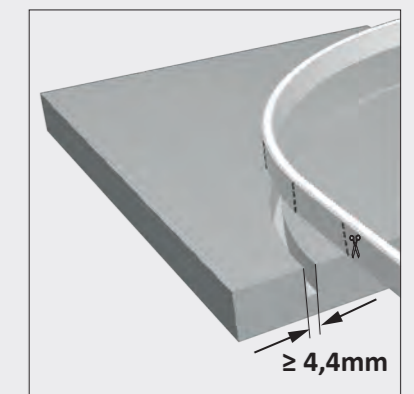
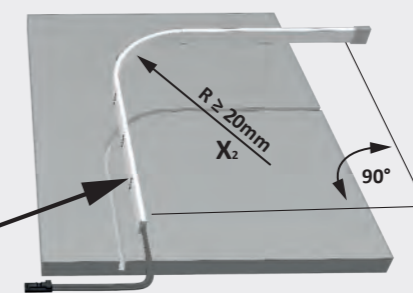
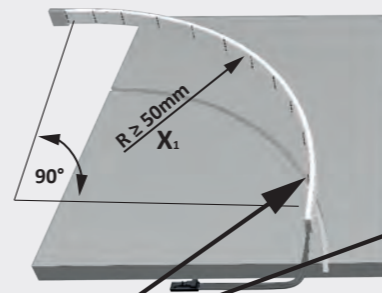
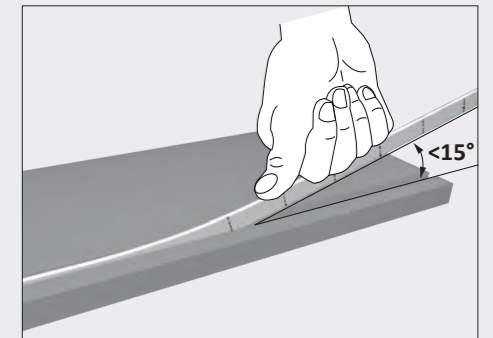
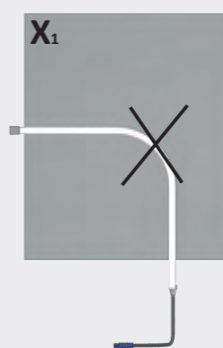
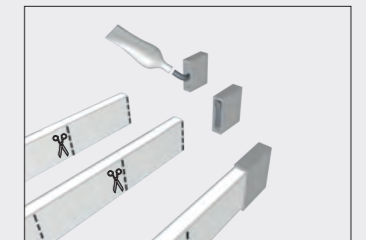
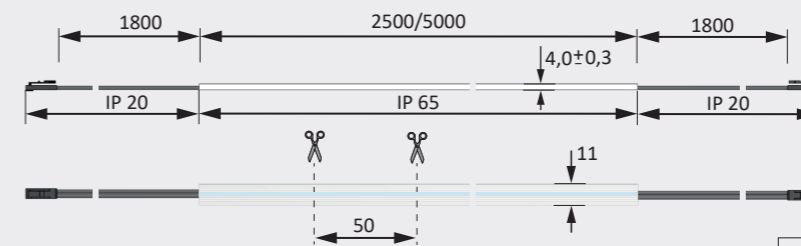

* Further accessories in section Switch systems