



## Point

### Advantages

- ▶ Compact light
- ▶ Evenly illuminated area
- ▶ Replaces a matte-finished 10 W halogen light

### Features

- ▶ Especially warm tone
- ▶ Recessed light with 58 mm installed diameter

### Examples of use

- ▶ Shelves
- ▶ Display cabinets

### Ordering information

- ▶ To find the right combination of light and ballast, please note pictograms in the light catalogue!
- ▶ Sales unit: 1





### Technical details in brief



Lamp type: LED recessed light  
 Type of lighting: Functional / accent lighting  
 Surface finish: Aluminium look  
 Operating voltage: 12 V DC  
 Light colour: Extra warm white

Colour rendering index CRI: > 80  
 Energy efficiency: A

Life span: 30,000 h (L70)  
 Power consumption: 2.7 W  
 Dimmable: Yes  
 Beam angle: 60°

Test marks and symbols:      
 Protection rating: IP 44  
 Installed diameter: 55-58 mm  
 Supply lead: 1000 mm  
 Plug connection: LED mini  
 M1 plug connection  
 Connection to: LED ballast

### Point

Article	Order no.
Aluminium look	32 962 17

### Accessories (for more accessories, see chapters "Switch systems" and "Ballasts & leads")

Article	Order no.
LED ballast 20 W with flat Euro plug	31 016 01
M1 extension lead 1800 mm	36 768 01
M1 3-way distributor 180 mm	36 852 01
M1 6-way distributor 2000 mm	36 125 01

Light distribution diagram / 60°

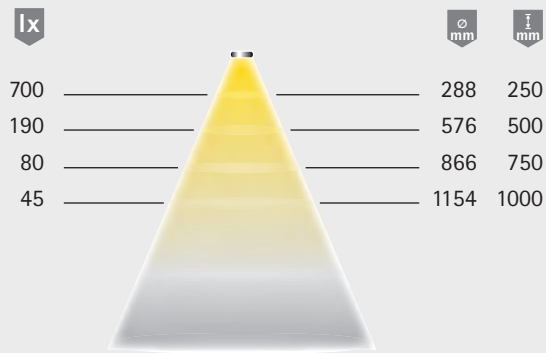

Light box

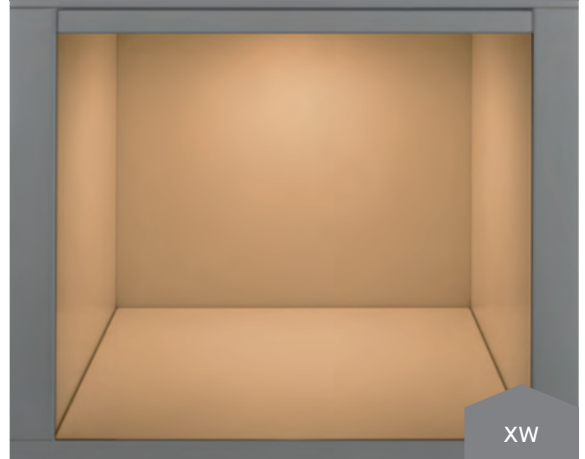

Dimensional drawing / installation

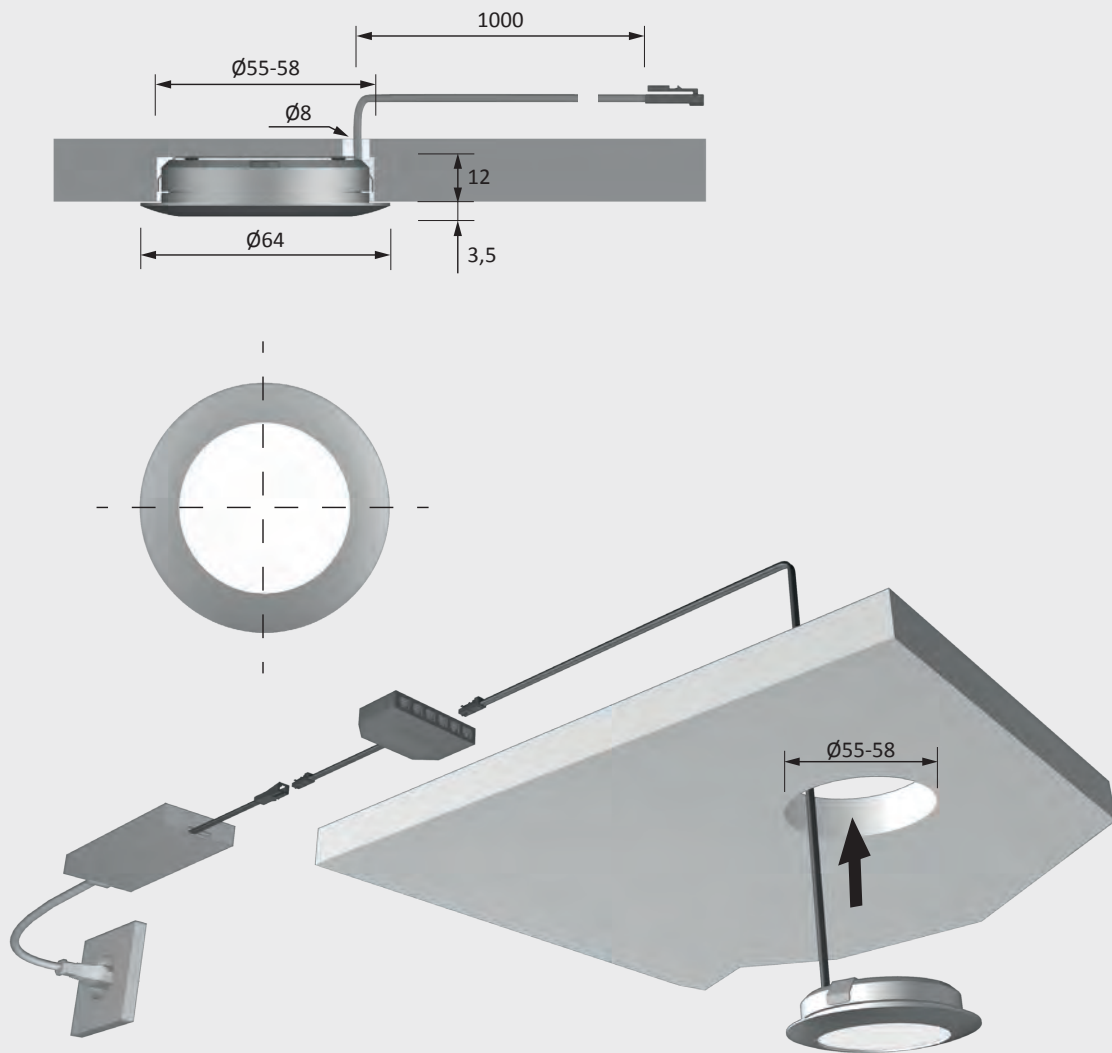

Spotlights